

Features:

- Ribbon Tweeter
- 2K Hz to 40K Hz Response
- 92 dB Sensitivity
- 4 Ohm Impedance
- Laminated Aluminum Diaphragm
- Ultra-thin Diaphragm

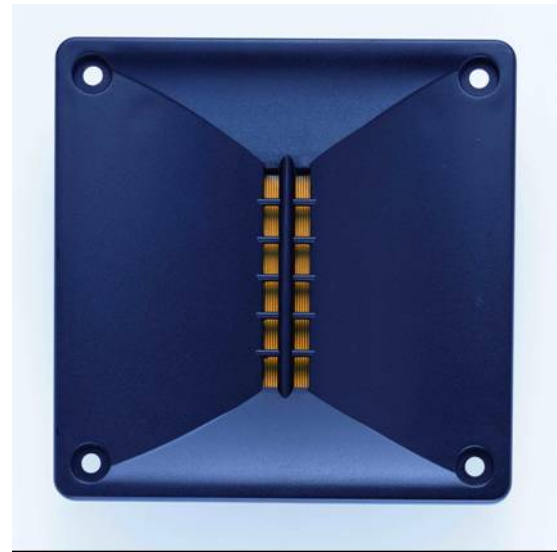

Specifications:

Nominal Impedance	4 Ohm
Frequency Response	2K Hz ~ 40K Hz
Sensitivity	92 dB @ 1W/1m
Recommended Crossover	More than 2.5 K Hz
Power Handling	40 W Continuous / 3 rd Crossover, $Q \leq 0.707$
Diaphragm	Laminated Aluminum
Magnet	Nd-Fe-B
Weight	175 grams

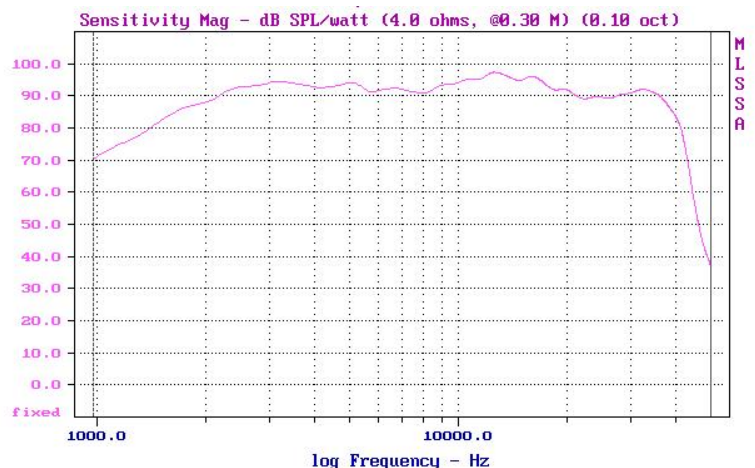
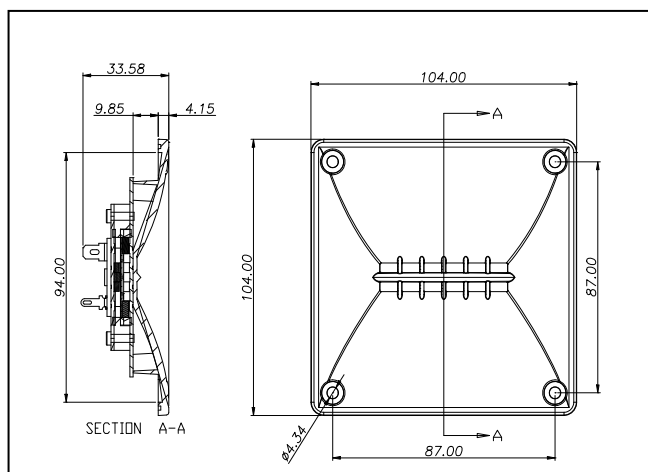

BESTON Technology Corporation

Office: 5F-13, No. 9, Ai Kuo West Rd., Taipei 100, Taiwan

TEL: (886)-2-23892956 FAX: (886)-2-23892952

E-Mail: s272@ms45.hinet.net